

CPRI

TEST REPORT



Central Power Research Institute

**(A Govt. of India Society,
P.B. No. 8066, Sadashivanagar, S.P.O.
Prof. Sir. C.V. Raman Road,
Bangalore - 560 080**



CPRI

HIGH VOLTAGE DIVISION
CENTRAL POWER RESEARCH INSTITUTE
P.B. NO. 8066, SADHASHIVNAGAR SUB P.O.
Prof. SIR. C.V. RAMAN ROAD, BANGALORE - 560 080, INDIA.
Phone : +91 (0)80-23601917 Fax : +91 (0)80-23601917



NABL Accredited
Laboratory
Certificate No. T-0010

MEMBER STL

Sheet 1 of 3

TEST REPORT

Test Report Number : No.43/1/2009-HV/7305/KEPL
Name & Address of the Customer : M/s. Krishnaa Energy Pvt. Ltd.,
DP 69 Sidco Industrial Estate,
Thirumudivakkam,
Chennai-600 044.
Ref: KEPL-002

Dated: 03-12-2009.

Dated: 04-11-2009

Name & Address of the Manufacturer : M/s. Krishnaa Energy Pvt. Ltd.,
DP 69 Sidco Industrial Estate,
Thirumudivakkam,
Chennai- 44.

Particulars of Sample tested.

Condition of sample on Receipt : After SCT Test.
Type : KEPL.
Designation : 11kV, 1250A, 25kA, 3Φ Load Break Switch Panel.
Serial Number : Sample-1.
Number of samples tested : One.
Date(s) of Test(s) : 11-11-09
CPRI Sample Code Number : SC 2009 S1826

Particulars of tests conducted : 1) Lightning Impulse Voltage Withstand Test.
Test in accordance with standard/Specification. : IS 3427/1997 RA 2007.
Sampling plan : Not Applicable.
Customer's requirement : Nil.
Deviations if any : Nil.

Name of the witnessing persons

Customer's representatives : Mr. P. Ramachandran, Manager, R&D.
Other than Customer's representatives : None.
Test/subcontracted with : None.
Address of the laboratory. : None.

Documents constituting this report (In words).

Number of Sheets : Three.
Number of oscillogram/s : Twenty.
Number of graphs : Nil.
Number of photo/s : Nil.
Number of Test Circuit Diagrams : Nil.
Number of Drawings : Two.{Drawing Nos.1) KELBS 03-001 Sheet No. 01 of 01
2) KELBS 03-002 Sheet No. 01 of 01}.

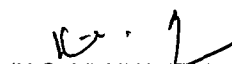
(K.G. VENKATESH)
Test Engineer

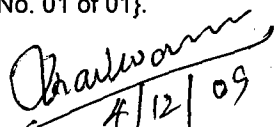
(P. V. VASUDEVAN NAMBU DIRI)
Additional Director

AUTHORISED SIGNATORIES



CPRI

HIGH VOLTAGE DIVISION
CENTRAL POWER RESEARCH INSTITUTE
P.B. NO. 8066, SADHASHIVNAGAR SUB P.O.
Prof. SIR. C.V. RAMAN ROAD, BANGALORE - 560 080, INDIA.
Phone : +91 (0)80-23601917 Fax : +91 (0)80-23601917

MEMBER STL



NABL Accredited
Laboratory
Certificate No. T-0010

Sheet 2 of 3

Test Report No.43/1/2009-HV/7305/KEPL

Dated: 03-12-2009.

Test Arrangement for the Test

Table with 4 columns: Test Arrangement, Switch Position, H.V. connected to, Earth connected to. Rows 1-5.

For test arrangement 4 & 5 frame was isolated.

Lightning Impulse Voltage Withstand Test

Table with 7 columns: Test Arrangement, No. of Shots, Positive, Osc No., Negative, Osc. No., Remarks. Rows 1-5 with sub-rows for 1st and 15th shots.

Result: The Load Break Switch Panel has withstood the above mentioned Impulse voltage withstand test.

These voltages are applied under ambient conditions which are given below.

* These voltages are final values after applying corrections for ambient conditions, which are given below.

Table with 3 columns: Temperature in Degree Celsius (Dry Bulb, Wet Bulb), Atmospheric Pressure in mm of Hg.

(K.G. VENKATESH)
Test Engineer



CPRI

**HIGH VOLTAGE DIVISION
CENTRAL POWER RESEARCH INSTITUTE**

P.B. NO. 8066, SADHASHIVNAGAR SUB P.O.
Prof. SIR. C.V. RAMAN ROAD, BANGALORE - 560 080, INDIA.
Phone : +91 (0)80-23601917 Fax : +91 (0)80-23601917

MEMBER STL



**NABL Accredited
Laboratory
Certificate No. T-0010**

Sheet 3 of 3

Test Report No.43/1/2009-HV/7305/TEPL

Dated: 03-12-2009.

NOTE:

- a) The test results relate only to the items tested.
- b) Publication or reproduction of this report in any form other than by complete set of the whole report and in the language written is not permitted without the written consent of CPRI.
- c) Any Corrections/erasures invalidate this test report/certificate.
- d) Any anomaly/discrepancy in this test report/certificate should be brought to our notice within 45 days from the date of issue.
- e) The verification of the sample drawings by CPRI is limited to dimensional checks only wherever possible.

(K.G. VENKATESH)
Test Engineer

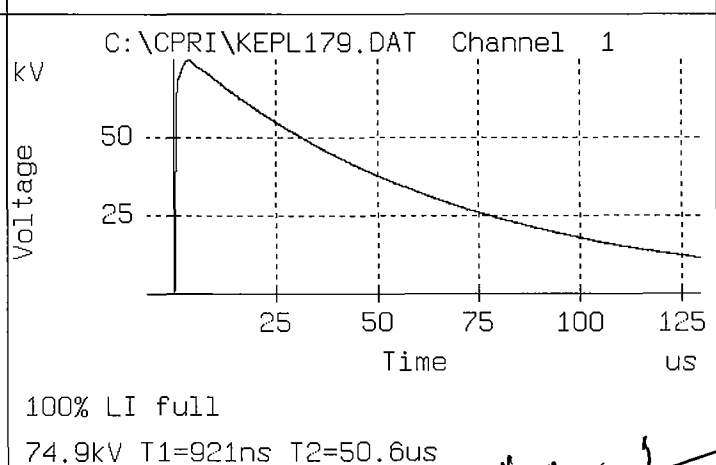
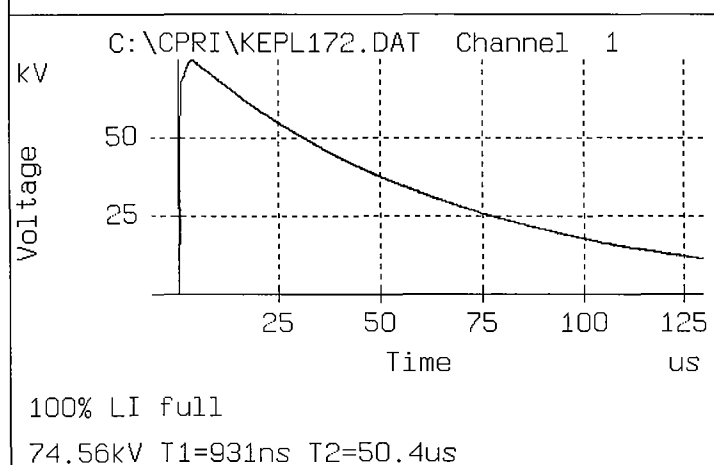
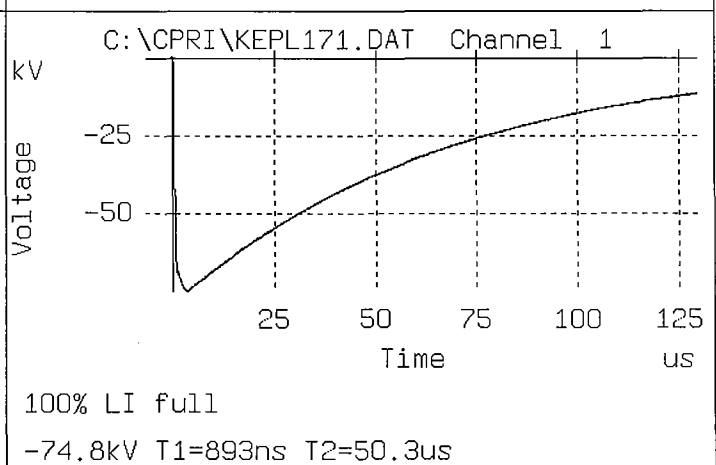
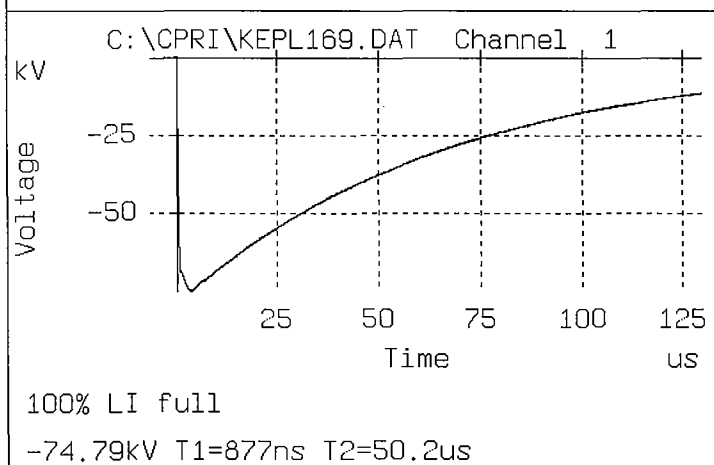
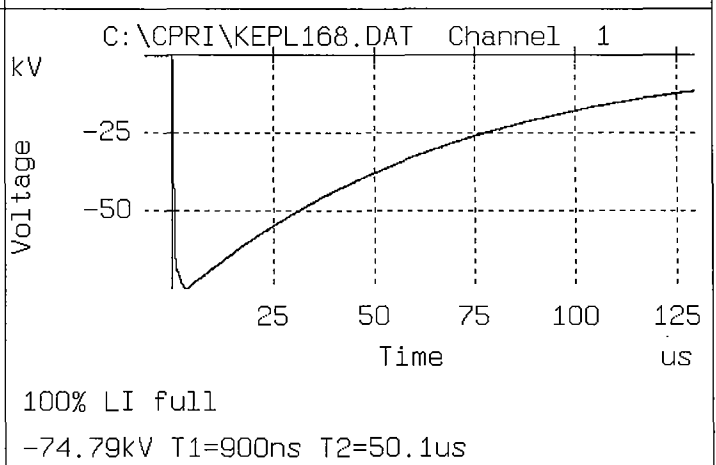
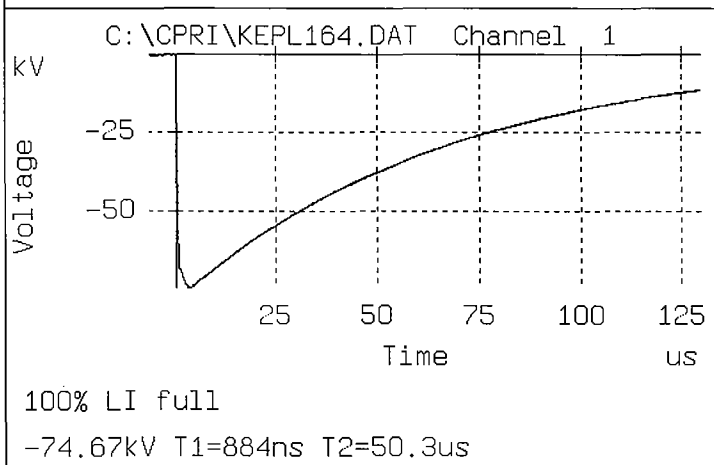
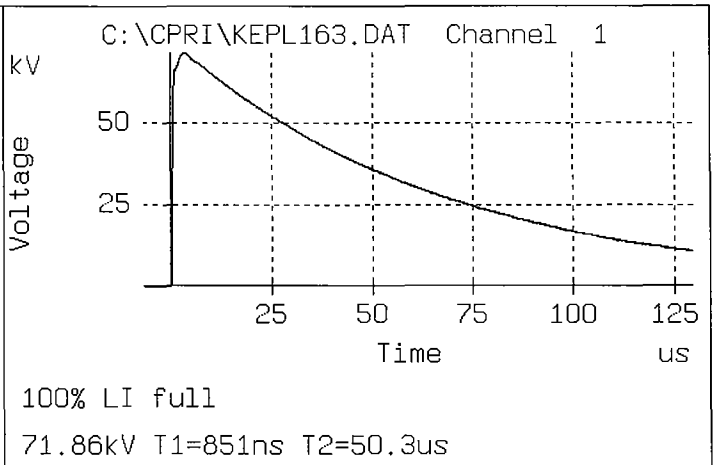
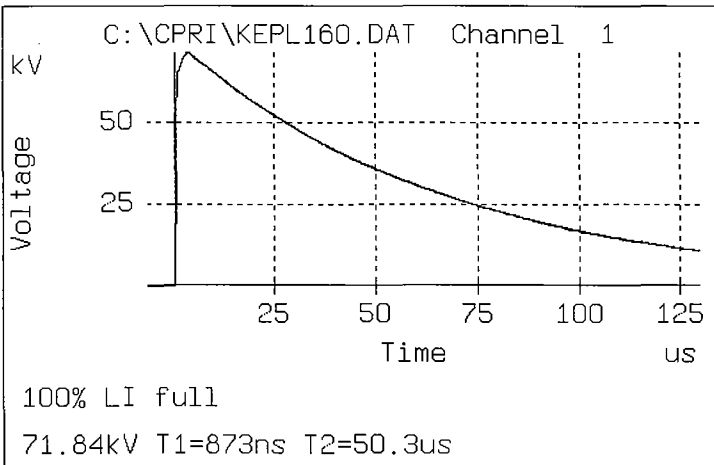

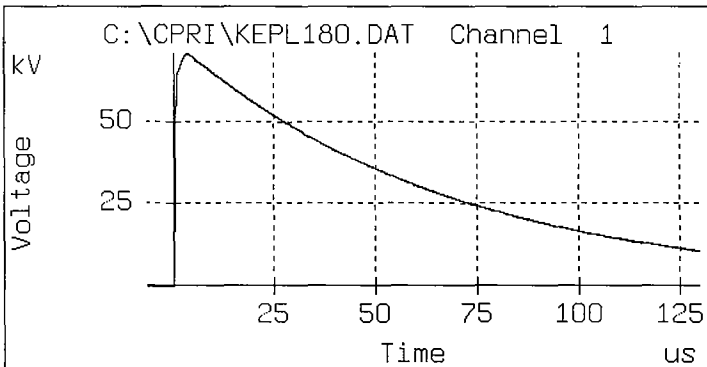

100% LI full
71.38kV T1=930ns T2=50.5us

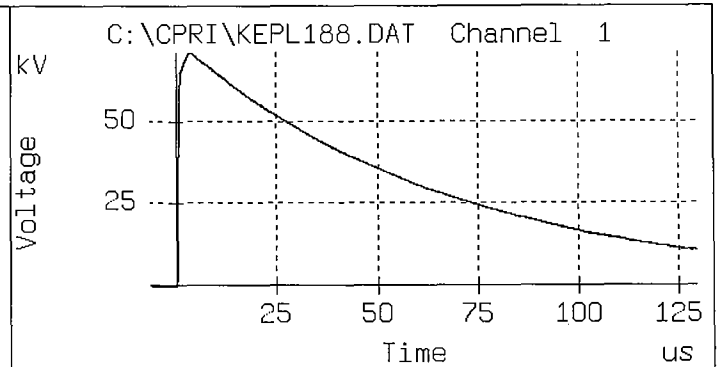

100% LI full
71.27kV T1=934ns T2=50.7us

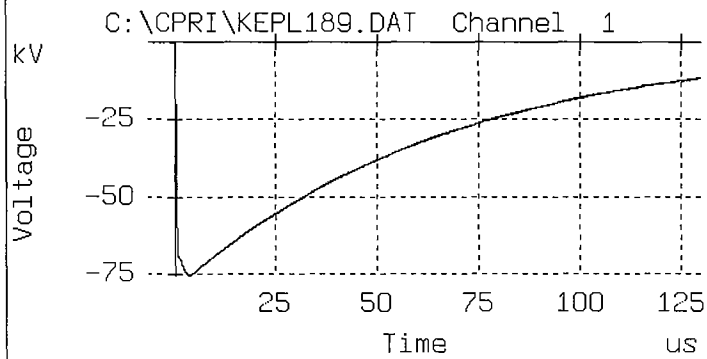

100% LI full
-75.27kV T1=891ns T2=50.4us

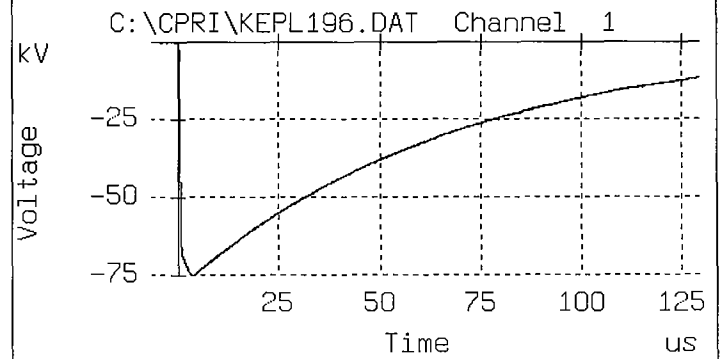

100% LI full
-75.15kV T1=912ns T2=50.4us

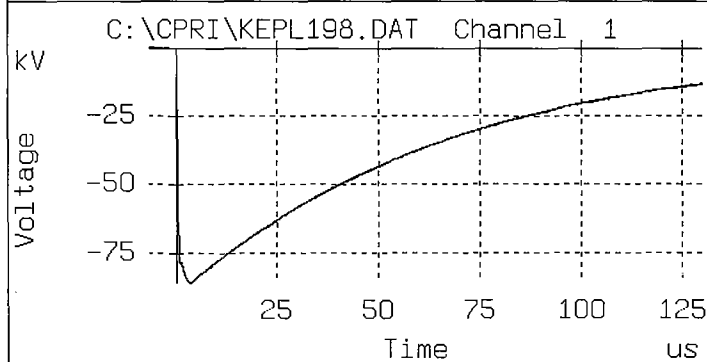

100% LI full
-85.84kV T1=920ns T2=50.3us

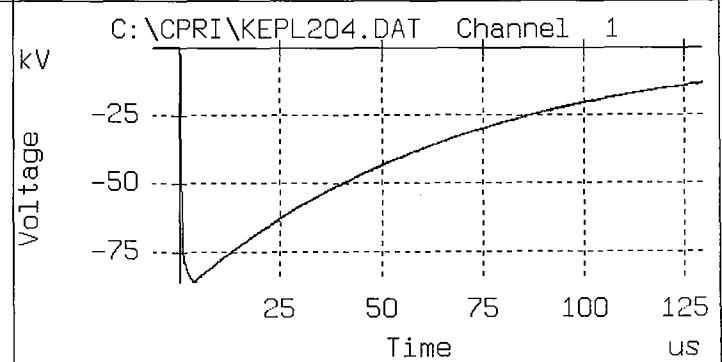

100% LI full
-85.84kV T1=882ns T2=50.2us

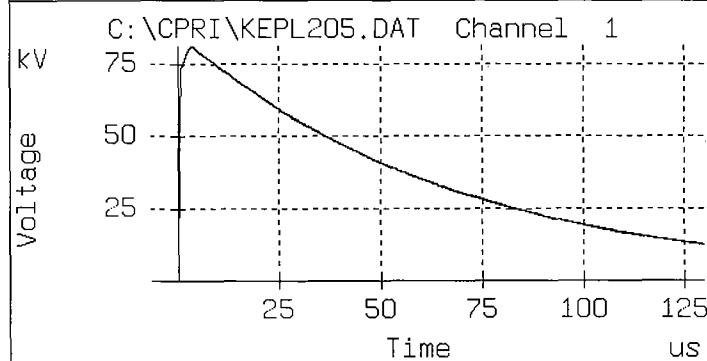

100% LI full
80.9kV T1=941ns T2=50.6us

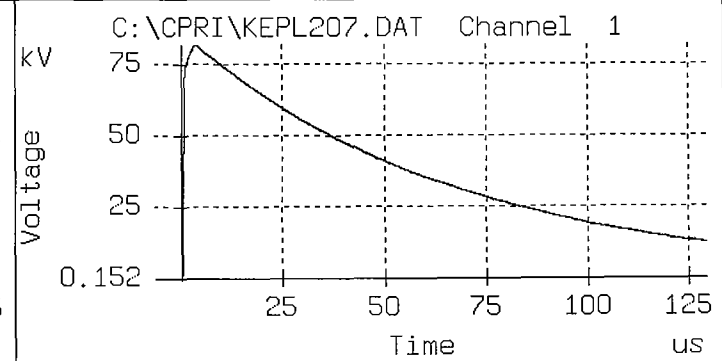

100% LI full
81.34kV T1=920ns T2=50.4us

THIS DRAWING IS THE PROPERTY OF MARUTHI ENERGY (INDIA) PVT LTD., AND MUST NOT BE COPIED OR REPRODUCED WITHOUT THEIR CONSENT.

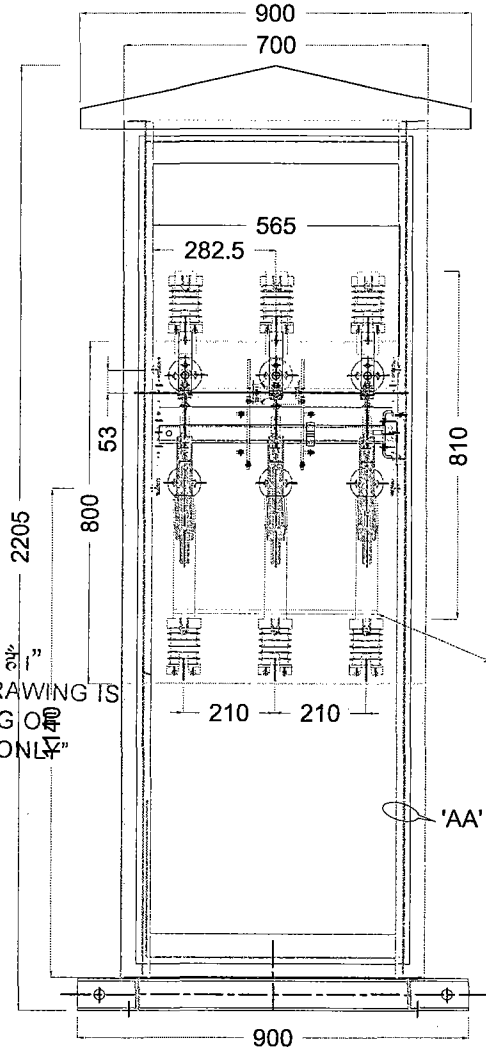
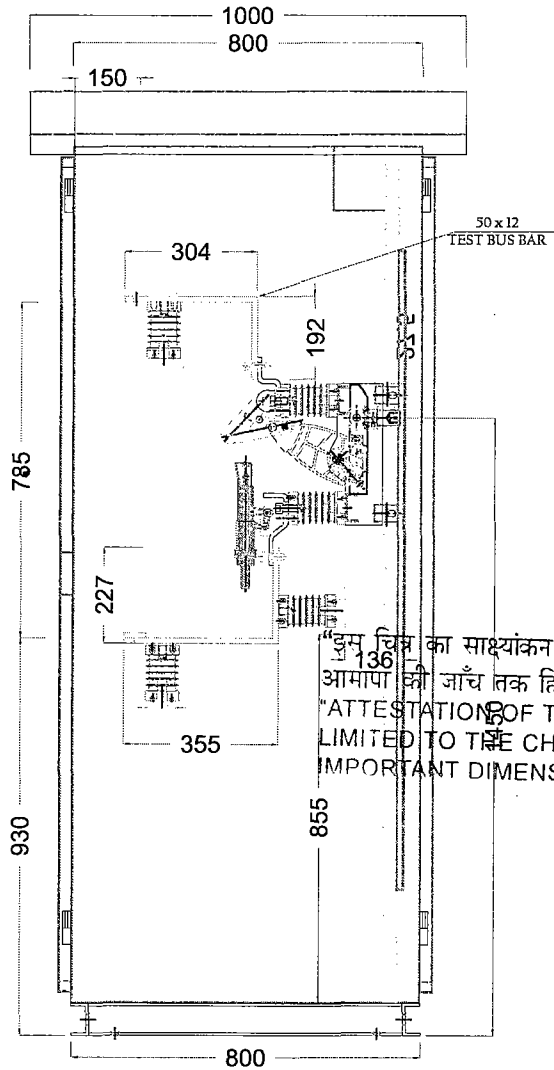

इस चित्र का साक्ष्यांकन महत्वपूर्ण
आमापा की जांच तक ही सीमित है।
"ATTESTATION OF THIS DRAWING IS
LIMITED TO THE CHECKING OF
IMPORTANT DIMENSIONS ONLY"

यह चित्र परीक्षण दस्तावेज सं. 43/1/.....
एचवी ता..... में संबन्धित है।
THIS DRAWING PERTAINS TO TEST REPORT
43/1/2009 HV/7305/KBPL
Dated..... 03.12.09

~~इंजीनियरी अधिकारी~~
ENGINEERING OFFICER
सी पी आर आई/CPRI
बेंगलूर/BANGALORE-560 080

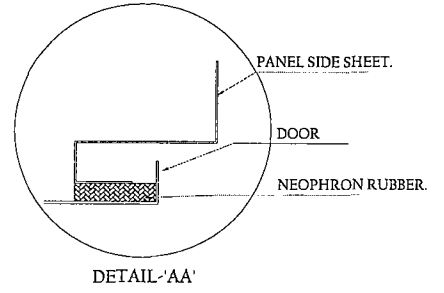

MATL : MS SHEET		QTY: 1NO.		ALL DIMENSIONS ARE IN mm		DESCRIPTION: PANEL ASSEMBLY		SHEET.No.	
FINISH: NATURAL						MFG BY:		SCALE : N.T.S.	
						KRISHNAA ENERGY PVT LTD., DP:69, SIDCO Industrial Estate, Thirumudivakkam, Chennai-44 www.maruthienergy.com		1 OF 1	
0		D.JAI	P.R	S.N	25/12			DRAWING NO:	
REV.	DATE	REMARKS	DRAWN	CHD.	APPD.	SIGN	DATE.	FILE NAME: F:\L B S\CPRI\MANF	CUSTOMER :
									REF.No:

THE POLICY OF MARUTHI ENERGY IS CONTINUAL IMPROVEMENT & DEVELOPMENT.

THIS DRAWING IS THE PROPERTY OF MARUTHI ENERGY (INDIA) PVT LTD., AND MUST NOT BE COPIED OR REPRODUCED WITHOUT THEIR CONSENT.

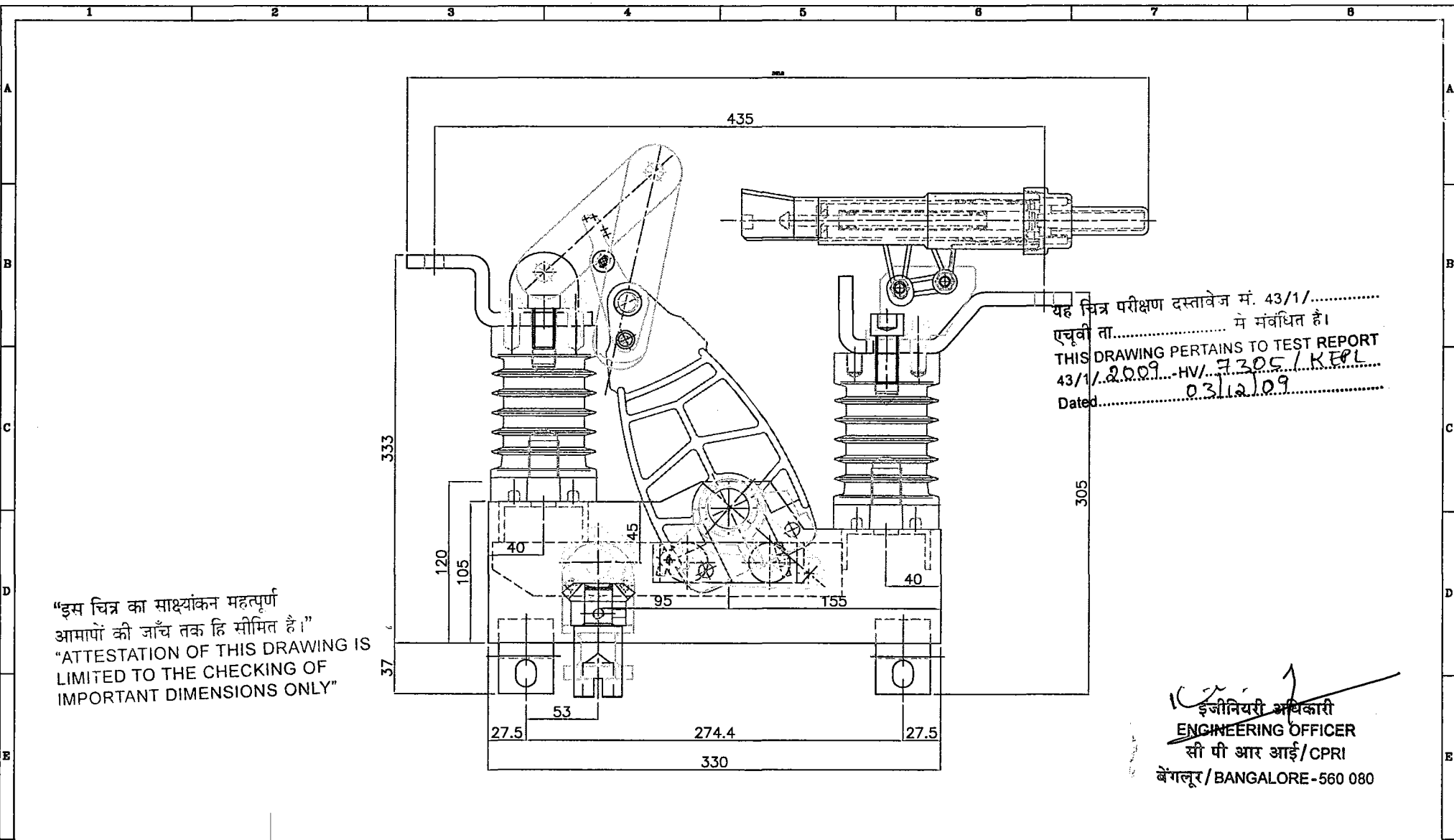

यह चित्र परीक्षण दस्तावेज नं. 43/1/.....
 एचवी ता..... में मंथित है।
 THIS DRAWING PERTAINS TO TEST REPORT
 43/1/2009-HV/7305/KEPL
 Dated..... 03.12.09

[Signature]
 इंजीनियरी अधिकारी
 ENGINEERING OFFICER
 सी पी आर आई/CPRI
 बेंगलूर/ BANGALORE-560 080

MATL :		QTY: 1NO.		ALL DIMENSIONS ARE IN mm				DESCRIPTION: SWITCH ASSEMBLY			SHEET.No.	
FINISH: NATURAL								MFG BY:			SCALE : N.T.S.	
								KRISHNAA ENERGY PVT LTD., DP: 69, SIDCO Industrial Estate, Thirumudivakkam, Chennai-44 www.maruthienergy.com			1 OF 1	
0		D.JAI		P.R		S.N		25/12		DRAWING NO: kELBS 03-002		
REV.	DATE	REMARKS		DRAWN	CHD.	APPD.	SIGN	DATE.	FILE NAME: F:\L B S\CPRI\MANF	CUSTOMER :	REF.No:	
1												

THE POLICY OF MARUTHI ENERGY IS CONTINUAL IMPROVEMENT & DEVELOPMENT.