

CPRI

TEST REPORT



Central Power Research Institute

(A Govt. of India Society)

**P.B.No. 8066, Sadashivanagar Post Office,
Sir C.V. Raman Road,
Bangalore - 560 080 (INDIA)**



CPRI

**SHORT CIRCUIT LABORATORY
CENTRAL POWER RESEARCH INSTITUTE**

(Member of STL)

P.B.NO.8066, SADASHIVANAGAR POST OFFICE
SIR C.V.RAMAN ROAD, BANGALORE - 560 080 (INDIA)
Phone : +91 (0) 80 - 23602662 Fax : +91 (0) 80 - 23601213

Sheet 1 of 5

TEST REPORT

Test Report Number	SC09617A	dated: 4 th November, 2009
Name & Address of the Customer	M/s. Krishnaa Energy Private Limited, DP:69, SIDCO Industrial Estate, Thirumudivakkam, Chennai - 600 044	
Name & Address of the Manufacturer	M/s. Krishnaa Energy Private Limited, DP:69, SIDCO Industrial Estate, Thirumudivakkam, Chennai - 600 044	
Particulars of sample tested	L.T. Current Transformer	
Condition of the sample on Receipt	New	
Type	Indoor, ring, tape insulated	
Designation	---	
Serial Number	001 / 09	
Number of samples tested	One	
Date (s) of test (s)	23 rd September, 2009	
CPRI sample code no(s)	SC09S1809	
Particulars of tests conducted	Accuracy	
Test in accordance with Standard / specification	Customer's instruction following the procedure stipulated in sub-clause 7.1.1.1 of IS 2705 (Part 2): 1992 (Reaffirmed 2002)	
Sampling plan	Not applicable	
Customer's requirement	Accuracy test at rated burden only	
Deviations if any	---	
Name of the witnessing persons		
Customer's representative	Mr. K. S. Suresh Kumar, Manager - Production	
Other than customer's representative	None	
Test subcontracted with address of the laboratory	None	
Documents constituting this report (In words)		
Number of sheets	Five	
Number of oscillograms	Nil	
Number of graphs	Nil	
Number of photos	Nil	
Number of test circuit diagrams	Nil	
Number of drawings	One	

(Nagananda)
Test Engineer



(B. R. Ravishankar)
Joint Director

AUTHORISED SIGNATORIES



CPRI

**SHORT CIRCUIT LABORATORY
CENTRAL POWER RESEARCH INSTITUTE**

(Member of STL)

P.B.NO.8066, SADASHIVANAGAR POST OFFICE
SIR C.V.RAMAN ROAD, BANGALORE - 560 080 (INDIA)
Phone : +91 (0) 80 - 23602662 Fax : +91 (0) 80 - 23601213

Sheet 2 of 5
Report Number: SC09617A

Description of sample tested (rating as assigned by the manufacturer)

Test sample	Current transformer
Type	Indoor, ring, tape insulated
Designation	---
Serial number	001 / 09
Nominal system voltage	0.66 kV
Highest system voltage	0.72 kV
Rated insulation voltage	3.0 kV
Frequency	50 Hz
Number of cores	One
Rated Output-VA	5
Accuracy class	1.0
Rated transformation ratio	100 / 5 A

Documents attached to this report

Drawing number (s)

KEPL-LTCT-001 SHT.No. 1 OF 1 REV. 0

Test Engineer



CPRI

SHORT CIRCUIT LABORATORY
CENTRAL POWER RESEARCH INSTITUTE
(Member of STL)

P.B.NO.8066, SADASHIVANAGAR POST OFFICE
SIR C.V.RAMAN ROAD, BANGALORE - 560 080 (INDIA)
Phone : +91 (0) 80 - 23602662 Fax : +91 (0) 80 - 23601213

Sheet 3 of 5
Report Number: SC09617A

Schedule of test

ACCURACY TEST

Current ratio : 100 / 5
Accuracy class : 1.0
Primary connection : Single turn through window
Secondary connection : S1 - S2

Burden (VA) & Power factor	Type of error	Error at percentage primary current			
		120	100	20	5
5 & 0.8 lag	% Current error	- 0.243	- 0.305	- 0.928	- 1.788
	Phase displacement (min)	- 8.7	- 6.3	20.2	41.2

Ragunand
Test Engineer



CPRI

**SHORT CIRCUIT LABORATORY
CENTRAL POWER RESEARCH INSTITUTE
(Member of STL)**

P.B.NO.8066, SADASHIVANAGAR POST OFFICE
SIR C.V.RAMAN ROAD, BANGALORE - 560 080 (INDIA)
Phone : +91 (0) 80 - 23602662 Fax : +91 (0) 80 - 23601213

Sheet 4 of 5
Report Number: SC09617A

Details of the standard equipment (s) used for accuracy test

1) Automatic Instrument Transformer test set

Serial number 951105

Manufacturer M/s. Eltel Industries, Bangalore

Technical specification

a) Error measuring ranges

Range 1. +/- 19.99% & 19.99 C rad or 680 minutes
Range 2. +/- 1.999% & 1.999 C rad or 68.0 minutes
Range 3. +/- 1999 ppm & 1999 u rad or 6.80 minutes

b) Accuracy

i) Rated measuring value +/- 0.5% of reading +/- 0.5% of nominal input true rms

ii) Error measuring ranges

Range 1. +/- 1% of Reading +/- 0.04
Range 2. +/- 1% of Reading +/- 0.004
Range 3. +/- 1% of Reading +/- 10

c) Type ITS - 85

Calibration Calibrated at : National Physical Laboratory, New Delhi
Calibration valid upto : 20th March, 2010

2) Apparatus

Standard current transformer

Serial number 20012401

Manufacturer M/s. Eltel Industries, Bangalore.

Technical specification Ratio: 5...3200/5A
Accuracy: +/-0.005% at 1.0 VA

Calibration Inter-laboratory comparison done at S.C lab, CPRI, Bangalore
Comparison valid up to: 26th April, 2012

Test Engineer



CPRI

**SHORT CIRCUIT LABORATORY
CENTRAL POWER RESEARCH INSTITUTE
(Member of STL)**

P.B.NO.8066, SADASHIVANAGAR POST OFFICE
SIR C.V.RAMAN ROAD, BANGALORE - 560 080 (INDIA)
Phone : +91 (0) 80 - 23602662 Fax : +91 (0) 80 - 23601213

Sheet 5 of 5

Report Number: SC09617A

NOTE

- a) This is not a certificate of rating. A certificate of rating is not issued as only limited tests as requested by the customer were carried out.
- b) The test results relate only to the item(s) tested.
- c) Publication or reproduction of this report in any form other than by complete set of the whole report and in the language written, is not permitted without the written approval of CPRI.
- d) Corrections / erasings invalidate the test report.
- e) Any anomaly / discrepancy in the test report should be brought to our notice within 45 days from the date of issue.

Additional Information:

CPRI issues following types of reports/certificates:

Test Report:

The test report contains the record of the values of test parameters as obtained during testing, the physical condition of the sample during / after the test(s) and copy of oscillogram(s). Test report is issued when partial tests are performed as against the complete test requirement for proving specific ratings.

Sealed Certificate:

The sealed certificate is issued, on request and payment of the prescribed charges thereof only when the sample of particular type and rating has satisfactorily passed all the specified tests in compliance with the condition stipulated in a published National / International standard.

CPRI issues the following type test certificates based generally on STL Guidelines:

- I. Type test certificate of Short Circuit Performance.
- II. Type test certificate of Switching Performance.
- III. Type test certificate of Temperature Rise Performance.
- IV. Type test certificate of Dielectric Performance.
- V. Type test certificate of complete type test.

Test Engineer

THIS DRAWING IS THE PROPERTY OF KRISHNAA ENERGY PRIVATE LIMITED AND MUST NOT BE COPIED OR REPRODUCED WITHOUT THEIR CONSENT.

THE POLICY OF KRISHNAA ENERGY IS CONTINUAL IMPROVEMENT & DEVELOPMENT.

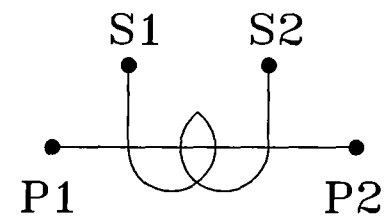
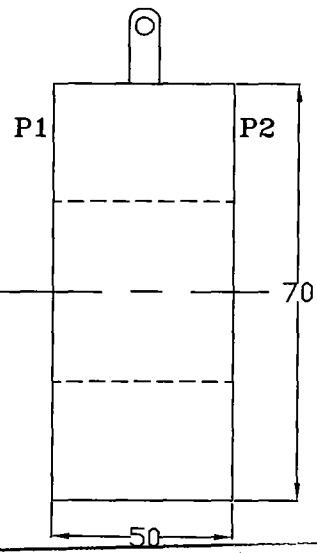
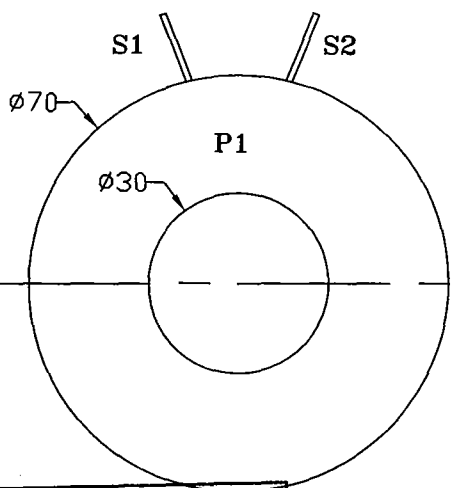

कें.वि.अ.सं. द्वारा इस रेखाचित्र का सत्यापन जहाँ कहीं भी संभव हो सिर्फ विमीय जाचें तक ही सीमित है।
 THE VERIFICATION OF THIS DRAWING BY CPRI IS LIMITED TO DIMENSIONAL CHECKS ONLY WHEREVER POSSIBLE



रिपोर्ट क्रमांक.....
 से संबंधित दस्तावेज
 Document Pertaining to
 Report No.: SC09617A

LT TAPE CT

RATING PLATE

CURRENT TRANSFORMER
 RATIO : 100 / 5A BURDEN : 5 VA/CL 1.0
 HSV : 660 V 50Hz ILV : 0.66/3 KV IS 2705/1992
 SL.NO. : 001/09 MFD. YEAR : 09
 MFD.BY :  KRISHNAA ENERGY PVT LTD., CHENNAI - 44

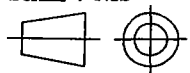
Ragunath
 परीक्षण अभियन्ता / Test Engineer
 ल.प. प्रयोगशाला / S. C. LAB
 सी. पी. आर. आई. / CPRI
 बेंगलूर / Bangalore

TYPE: INDOOR TAPE INSULATED		QTY: -		ALL DIMENSION ARE IN mm			TITLE: TAPE INSULATED CURRENT TRANSFORMER			SCALE : NTS		
0		BJM	K.S.S.K	K.S.S.K		21/9/09	MFG BY: 					
REV.	DATE	DESCRIPTION	DRAWN	CHD.	APPD.	SIGN	DATE.	 KRISHNAA ENERGY PRIVATE LIMITED., DP:69, SIDCO Industrial Estate, Thirumudivakkam, Chennai-44 www.krishnaenergy.net			SHT.No.	DRAWING No.
CUSTOMER : -										1 OF 1	KEPL-LTCT-001	