

CPRI

## TEST REPORT



**Central Power Research Institute**

(A Govt. of India Society)

P.B.No. 8066, Sadashivanagar Post Office,  
Sir C.V. Raman Road,  
Bangalore - 560 080 (INDIA)



CPRI

SHORT CIRCUIT LABORATORY  
CENTRAL POWER RESEARCH INSTITUTE

(Member of STL)

P.B.NO.8066, SADASHIVANAGAR POST OFFICE  
SIR C.V.RAMAN ROAD, BANGALORE - 560 080 (INDIA)  
Phone : +91 (0) 80 - 23602662 Fax : +91 (0) 80 - 23601213



T-0010

Sheet 1 of 5

TEST REPORT

<b>Test Report Number</b>	SC09617J	<b>dated:</b> 4 <sup>th</sup> November, 2009
<b>Name &amp; Address of the Customer</b>	M/s. Krishnaa Energy Private Limited, DP:69, SIDCO Industrial Estate, Thirumudivakkam, Chennai - 600 044	
<b>Name &amp; Address of the Manufacturer</b>	M/s. Krishnaa Energy Private Limited, DP:69, SIDCO Industrial Estate, Thirumudivakkam, Chennai - 600 044	
<b>Particulars of sample tested</b>	L.T. Current Transformer	
<b>Condition of the sample on Receipt</b>	New	
Type	Indoor, ring, resin cast	
Designation	---	
Serial Number	010 / 09	
Number of samples tested	One	
Date (s) of test (s)	23 <sup>rd</sup> September, 2009	
CPRI sample code no(s)	SC09S1818	
<b>Particulars of tests conducted</b>	Accuracy	
Test in accordance with Standard / specification	Sub-clause 7.1.1.1 of IS 2705 (Part 2): 1992 (Reaffirmed 2002)	
Sampling plan	Not applicable	
Customer's requirement	None	
Deviations if any	Nil	
<b>Name of the witnessing persons</b>		
Customer's representative	Mr. K. S. Suresh Kumar, Manager - Production	
Other than customer's representative	None	
Test subcontracted with address of the laboratory	None	
<b>Documents constituting this report (In words)</b>		
Number of sheets	Five	
Number of oscillograms	Nil	
Number of graphs	Nil	
Number of photos	Nil	
Number of test circuit diagrams	Nil	
Number of drawings	One	

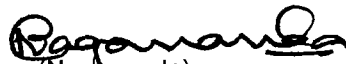
  
(Nagananda)  
Test Engineer



  
(B. R. Ravishankar)  
Joint Director

AUTHORISED SIGNATORIES



CPRI

**SHORT CIRCUIT LABORATORY  
CENTRAL POWER RESEARCH INSTITUTE**

(Member of STL)

P.B.NO.8066, SADASHIVANAGAR POST OFFICE  
SIR C.V.RAMAN ROAD, BANGALORE - 560 080 (INDIA)  
Phone : +91 (0) 80 - 23602662 Fax : +91 (0) 80 - 23601213



T-0010

Sheet 2 of 5

Report Number: SC09617J

**Description of sample tested (rating as assigned by the manufacturer)**

Test sample	Current transformer
Type	Indoor, ring, resin cast
Designation	---
Serial number	010 / 09
Nominal system voltage	0.66 kV
Highest system voltage	0.72 kV
Rated insulation voltage	3.0 kV
Frequency	50 Hz
Number of cores	One
Rated Output-VA	5
Accuracy class	1.0
Rated transformation ratio	200 / 5 A

**Documents attached to this report**

Drawing number (s)

KEPL-LTRCT-010 SHT.No. 1 OF 1 REV. 0

  
Test Engineer



**SHORT CIRCUIT LABORATORY  
CENTRAL POWER RESEARCH INSTITUTE**

(Member of STL)

P.B.NO.8066, SADASHIVANAGAR POST OFFICE  
SIR C.V.RAMAN ROAD, BANGALORE - 560 080 (INDIA)  
Phone : +91 (0) 80 - 23602662 Fax : +91 (0) 80 - 23601213



Sheet 3 of 5

Report Number: SC09617J

**Schedule of test**

**ACCURACY TEST**

Current ratio : 200 / 5  
Accuracy class : 1.0  
Primary connection : Single turn through window  
Secondary connection : S1 - S2

Burden (VA) & Power factor	Type of error	Error at percentage primary current			
		120	100	20	5
5 & 0.8 lag	% Current error	0.164	0.105	- 0.681	- 2.20
	Phase displacement (min)	- 4.3	- 3.1	11.8	37.0
1.25 & UPF	% Current error	0.834	0.811	0.512	- 0.088
	Phase displacement (min)	9.7	10.8	24.4	53.5

**Remarks:** The sample tested complies with the sub-clause of the standard referred to.

  
Test Engineer





**SHORT CIRCUIT LABORATORY  
CENTRAL POWER RESEARCH INSTITUTE  
(Member of STL)**

P.B.NO.8066, SADASHIVANAGAR POST OFFICE  
SIR C.V.RAMAN ROAD, BANGALORE - 560 080 (INDIA)  
Phone : +91 (0) 80 - 23602662 Fax : +91 (0) 80 - 23601213



Sheet 5 of 5

**Report Number: SC09617J**

**NOTE**

- a) This is not a certificate of rating. A certificate of rating is not issued as only limited tests as requested by the customer were carried out.
- b) The test results relate only to the item(s) tested.
- c) Publication or reproduction of this report in any form other than by complete set of the whole report and in the language written, is not permitted without the written approval of CPRI.
- d) Corrections / erasings invalidate the test report.
- e) Any anomaly / discrepancy in the test report should be brought to our notice within 45 days from the date of issue.

Additional Information:

CPRI issues following types of reports/certificates:

**Test Report:**

The test report contains the record of the values of test parameters as obtained during testing, the physical condition of the sample during / after the test(s) and copy of oscillogram(s). Test report is issued when partial tests are performed as against the complete test requirement for proving specific ratings.

**Sealed Certificate:**

The sealed certificate is issued, on request and payment of the prescribed charges thereof only when the sample of particular type and rating has satisfactorily passed all the specified tests in compliance with the condition stipulated in a published National / International standard.

**CPRI issues the following type test certificates based generally on STL Guidelines:**

- I. Type test certificate of Short Circuit Performance.
- II. Type test certificate of Switching Performance.
- III. Type test certificate of Temperature Rise Performance.
- IV. Type test certificate of Dielectric Performance.
- V. Type test certificate of complete type test.

  
Test Engineer

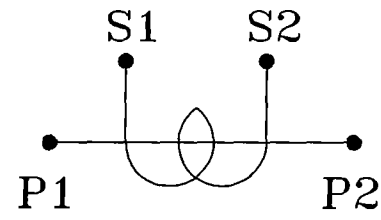
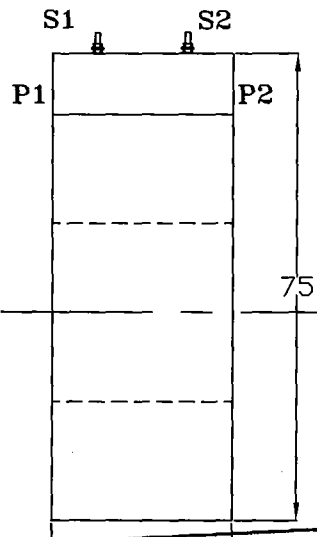
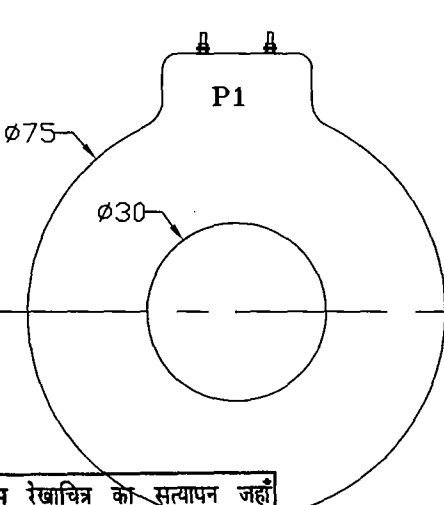

कें.वि.अ.सं. द्वारा इस रेखाचित्र को सत्यापन जहाँ कहीं भी संभव हो सिर्फ विमीय जाचें तक ही सीमित है।  
 THE VERIFICATION OF THIS DRAWING BY CPRI IS LIMITED TO DIMENSIONAL CHECKS ONLY WHEREVER POSSIBLE

रिपोर्ट क्रमांक 40  
 से संबंधित दस्तावेज  
 Document Pertaining to  
 Report No: 5C09617J

**LT RESIN CAST CT**

*Signature*

ल.प. प्रयोजिता / S. C. DAS  
 सी. पी. आर. आई. / CPRI  
 बंगलूर / Bangalore

**RATING PLATE**

CURRENT TRANSFORMER			
RATIO	: 200 / 5A	BURDEN	: 5 VA/CL 1.0
HSV	: 660 V 50Hz	ILV	: 0.66/3 KV IS 2705/1992
SL.NO.	: 010/09	MFD. YEAR	: 09
MFD.BY :	 <b>KRISHNAA ENERGY PVT LTD., CHENNAI - 44</b>		

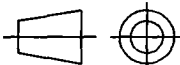
TYPE: INDOOR RESIN CAST		QTY: -	ALL DIMENSION ARE IN mm				TITLE: RESIN CAST CURRENT TRANSFORMER				SCALE : NTS		
0			BJM	K.S.S.K	K.S.S.K	21/9/09	MFG BY:  <b>KRISHNAA ENERGY PRIVATE LIMITED.,</b>						
REV.	DATE	DESCRIPTION	DRAWN	CHD.	APPD.	SIGN	DATE.	DP:69, SIDCO Industrial Estate, Thirumudivakkam, Chennai-44				SHT.No.	DRAWING No.
CUSTOMER : -							www.krishnaenergy.net				1 OF 1	KEPL-LTRCT-010	

ALL RIGHTS RESERVED BY KRISHNAA ENERGY PRIVATE LIMITED AND MUST NOT BE COPIED OR REPRODUCED WITHOUT THEIR CONSENT.

THE POLICY OF KRISHNAA ENERGY IS CONTINUAL IMPROVEMENT & DEVELOPMENT.